

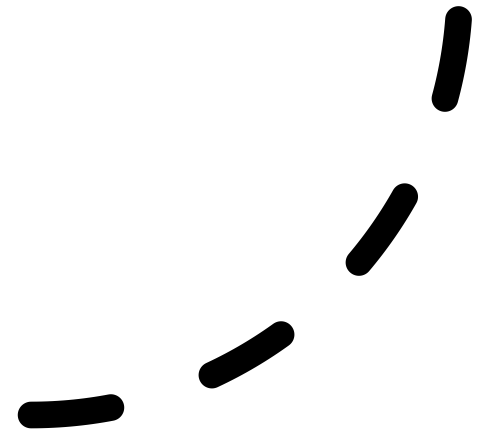

GOTTSEGEN
NEW
ENERGY
COLLECTION

- GOTTSEGEN 62 New Energy
Catamaran (Limited Edition)



CONTENTS

- 1, Project background introduction
 - 2, General Plan Introduction
 - 3, Product Innovation Highlights
 - 4, Project Prospect
- 

Uniquely Langkawi Island, malaysia

- The total length of Langkawi coastline is over 200 kilometers, with 9 high quality natural bays, and more than 99 coastal islands.
- The seasons are long summer without winter, and the climate is mild and humid.



Y A C H T M A R K E T E X P E N S I O N

At present, the yacht market in Langkawi Island has occupied more than 30% of the country's share, and the number of yachts has exceeded 1500 in West & East Malaysia.



With the rapid increase in the number of yachts emissions have gradually become the largest source of pollution in seaport and coastline.



MOVING FORWARDS

1, Langkawi, Malaysia Free Trade Port Yacht Industry Promotion Regulations.

2, Development of new energy and clean energy transportation tools

3, "Carbon Peak" in 2030

4, "Carbon Neutrality" in 2050

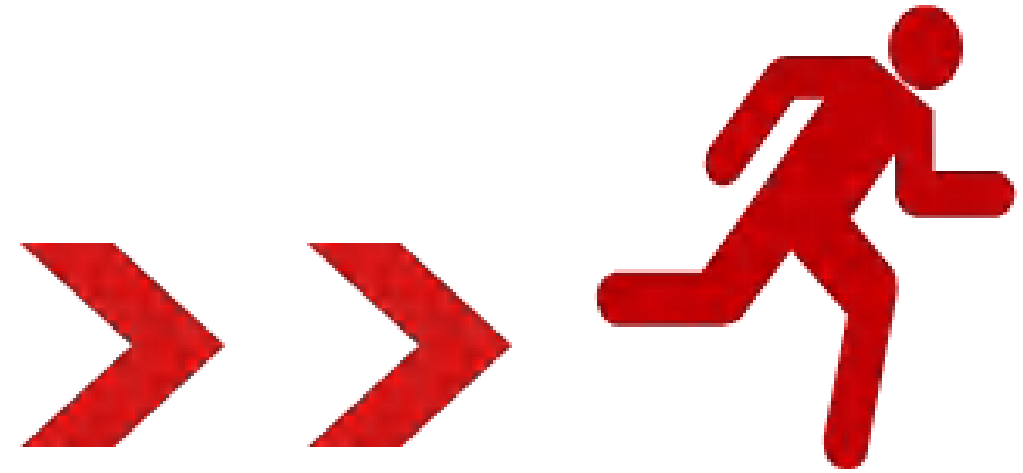

NZCE 2050



- The Malaysia government has targeted renewables to supply 45% -50% of its energy consumption by 2030, by implementing clean, sustainable, and renewable energy.
- Malaysia will target net-zero carbon emissions by 2050.
- The power sector plays a key role ensuring that the power system remains secure, reliable, and sustainable.
- As a type of recreational nautical that Malaysia focuses on, yachts should actively respond to the country's clean energy policy.
- With the implementation of the national double carbon target and 2030 plan in Malaysia, the sustainability & zero-emission of Malaysia, which encourage to promote the high quality development of yachting industry of Malaysia, and promote the localization and green transformation of the yacht industry and nautical tourism will be an inevitable new trend.

Part 2, GENERAL PLAN INTRODUCTION

1, Pure battery power propulsion

2, The design category is Category IV, and the design occupant quota is 24.

3, The length of the boat is 62 feet (about 18.9 meters), the width of the boat is 29.5 feet (about 9.0 meters), and the full load is 30 tons.

4, The speed is 10-14 knots, and the battery life is about 4 hours.



Tropical Charters Langkawi

Investable Interest with
Gottsegen 62 New Energy
Catamaran (Limited Edition)

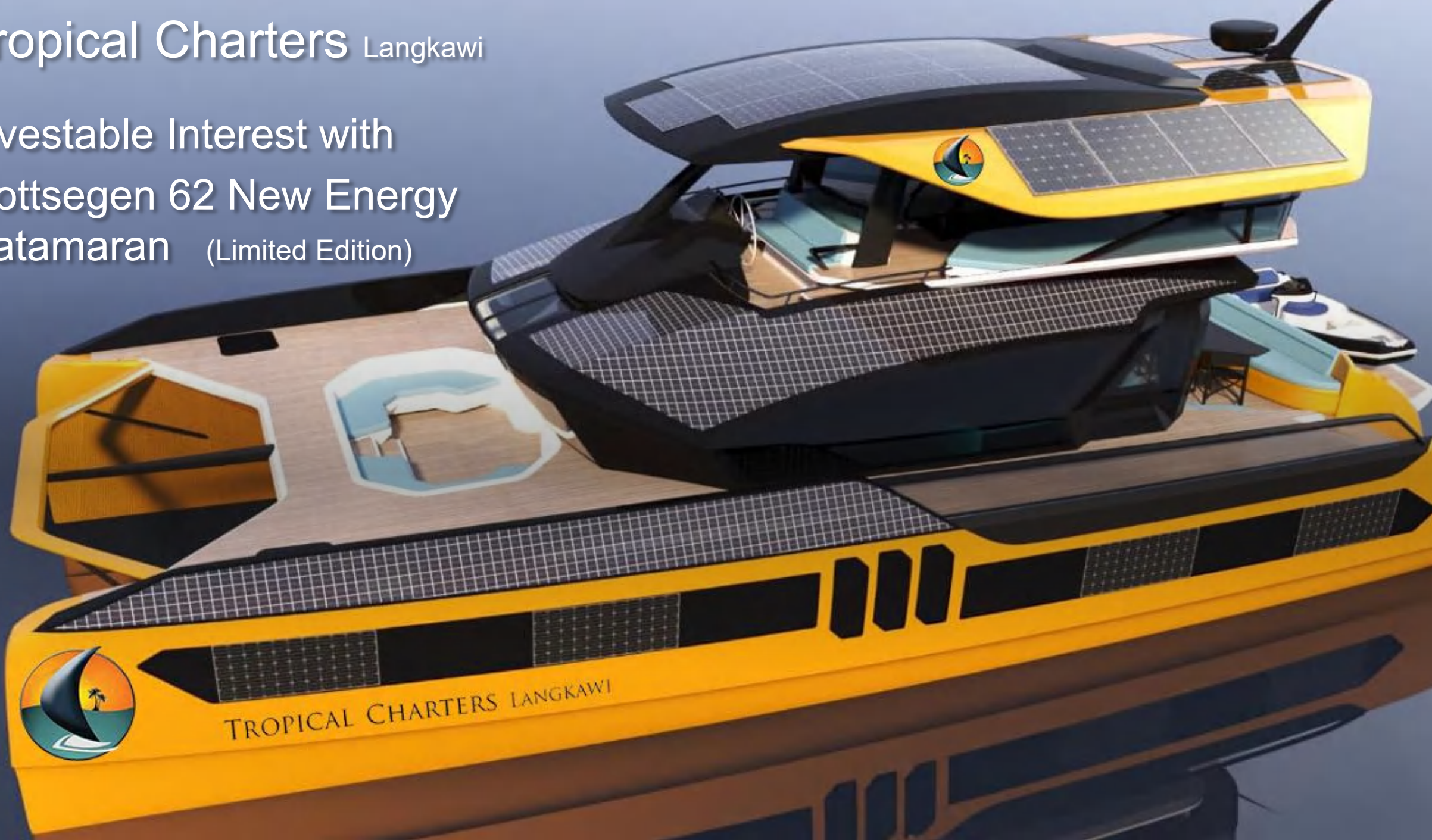

Technical Specification

- The Gottsegen 62 is 18.90 meters cruising new energy catamaran with a standard 2 guest cabins and the draft of 0.92 meters which can reach up to 12 knots. This catamaran is built with fiberglass / grp hull has CCS Certification.
- Length : 18.90 m / 62'
- Beam : 9.00 m / 29' 6"
- Draft : 0.92 m / 3' 5"
- Tonnage
- Displacement, 30t (full load)
- Fuel capacity, 500 l
- Water tank, 1000 l
- Wastewater tanks; 2 x 500 l
- Passenger capacity
- Max people: 6-24
- Cabins: 2 -4
- Berths for guests: 4-8
- Bathrooms: 2-4
- Crew: 2
- Solar Panel & Power
- Estimated 48 panel and 19.2 Kwp with Energy Harvest with approximately 120Kwh / day.
- Battery Capacity
- 180-360 Kwh
- Engines and performance Engine options
- Pod drive: 2 x 100-250 kW
- Cruising Speed: 6-8 knots
- Max Speed: 10-12 knots
- DC Genset: 60 – 100 Kw
- Classification :CCS Certified (CE Certification is available upon request)

Highlights

- *Unlimited range; 5 year warranty of hull & GRP parts; 2 year warranty of general fitting & finishes;
 - Zero maintenance & 25-year warranty of the photovoltaic module Solar panels; Zero maintenance &
 - 10 year warranty of Lithium LiFeO₄ Batteries; Zero maintenance & lifetime warranty of electric motor;
 - Noiseless & fume-less; Fuel-bill-less; Marina electric-bill-less; Environment-friendly with an inspiring
 - sunrise and a breath-taking romantic sunset, while cruising on the water !
 - *Gottsegen Yachts has good relationship with China Yacht Builder who has established with China
 - most reliable energy & drivetrain upgraded battery technology such as Reluctance Assisted
 - Permanent Magnet (SRPM) system, as well as the Pod Thruster propeller system.
- 

High Reliability Battery Power Integration System

- The battery packs are independent of each other, any battery failure will not affect the normal operation of other battery packs.
- In the thermal runaway state of any one battery cell or one battery module in the battery pack, it will not cause thermal runaway of the battery system.
- The ship adopts the DC power distribution electric propulsion system, there is no problem of frequency and phase matching, and the energy utilization efficiency is improved.
- Realize the selective protection of DC grid short-circuit current through DC fast fuses, which can ensure the continuous power supply of the ship grid when short-circuited at any position (not the DC busbar).
- The inverter power supply outputs high-quality AC power, which can meet the requirements of impact loads.
- The propulsion inverter has a low voltage fault ride-through function. The propulsion inverter will not shut down when the DC grid voltage dips for a short time.
- A special charging device is equipped for the power battery system to ensure the stability of charging.

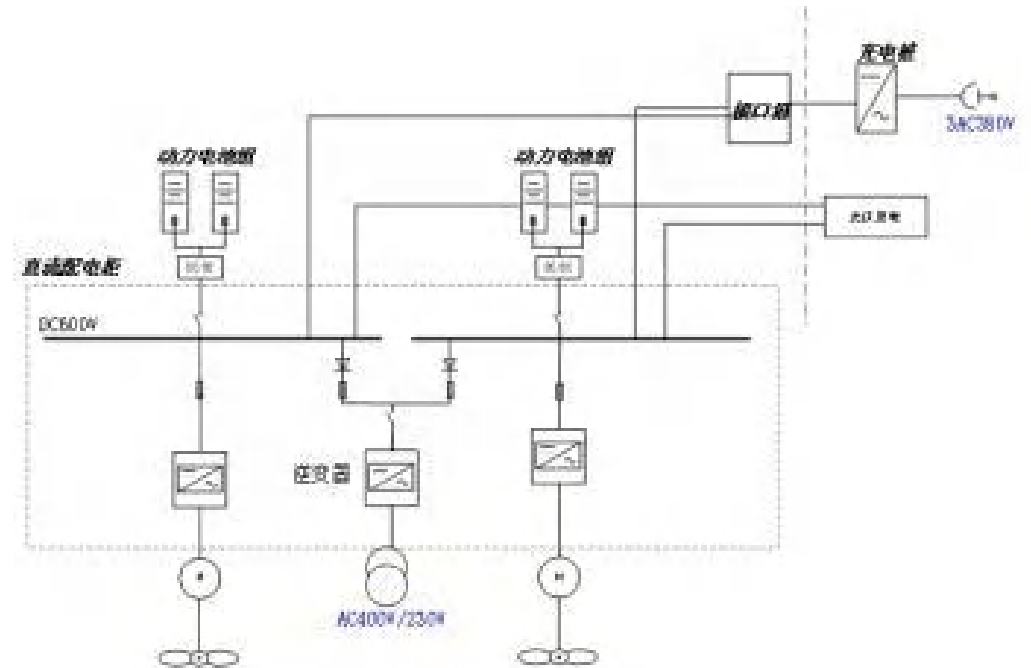

Power System Schematic

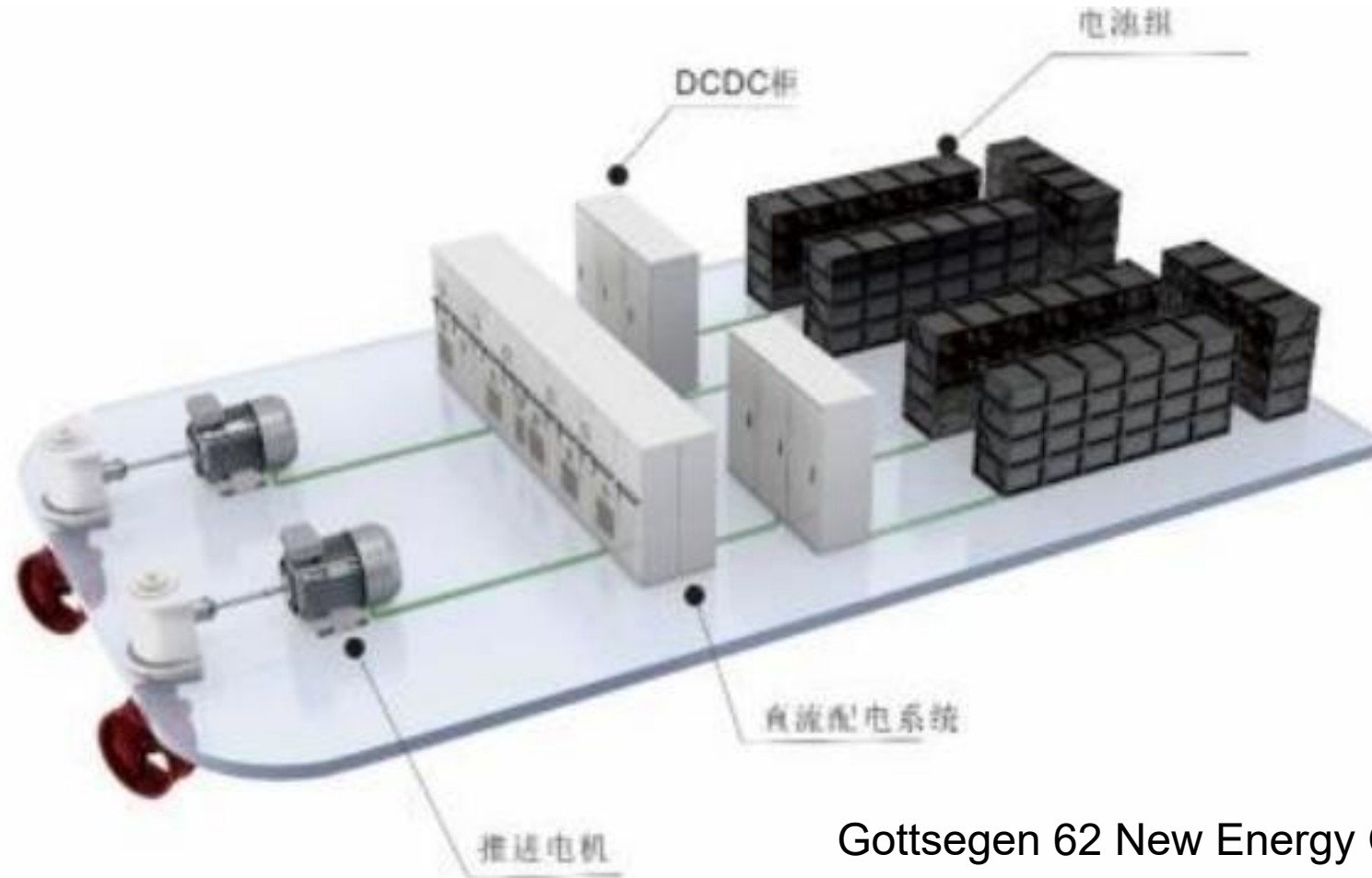

Gottsegen 62 New Energy Catamaran (Limited Edition)

Hull Structural Materials

Manufactured by glass-fibre-reinforced plastic vacuum adsorption process, the hull, superstructure, structural bulkhead, deck, deckhouse, and columns are all constructed of non-combustible materials or fire-resistant materials with sufficient structural performance, and the fire-resistant materials meet the requirements of FSS regulations.



Fire Separation

The battery compartment is enclosed by fire-resistant partitions, and its bulkhead and deck adopt A60 fire-resistant and flame-retardant structure.

The selected fire-resistant cotton is tested in accordance with the relevant requirements of FSS regulations and has a structural fire-resistant time of at least 60 minutes.



Program Layout

- Installed in a dedicated battery compartment.
- The smallest detachable unit is 96kg.
- Satisfaction
- Minimum height of sheet battery compartment: 2.3m, height of unilateral battery pack: 1.035m
- Sheet battery compartment width: 1.5m, single side battery pack width: 0.66m



Battery Compartment Layout

Requirements

- Batteries with a total storage capacity greater than 200Kwh shall be installed in the battery compartment or in the battery box (cabinet) on the open deck.
 - For ships with a length of less than or equal to 20m, the weight of the minimum detachable unit for quick maintenance of any battery shall be less than or equal to 130kg.
 - When the propulsion batteries are arranged in the cabin, they shall be separately arranged in at least two dedicated cabins.
 - The clear distance between the battery box (cabinet) or the battery pack and the bulkhead and the upper deck shall not be less than 150mm, and the clear distance from the bulkhead and the upper deck reinforcement structure shall not be less than 100mm.
 - The minimum horizontal distance from the battery box (cabinet) and the battery pack to the outer shell and structure of the hull is not less than 300mm, and the minimum horizontal distance to the inner plate and structure of the catamaran hull is not less than 150mm.
- 

Ship Design

The hull is a 62-foot catamaran. Compared with the V-bottom monohull with the same length, the stability is better than that of a V-bottom monohull.

It has the characteristics of small draft and low power propulsion resistance.



Pod Thruster

- It allows the ship to realize 360-degree steering and movement without dead angle.
- While improving the manoeuvrability of the ship, it can be driven remotely and laterally (to facilitate docking of the ship) and has an electronic anchoring function.
- The boat can be equipped with multi-point thruster as an option.

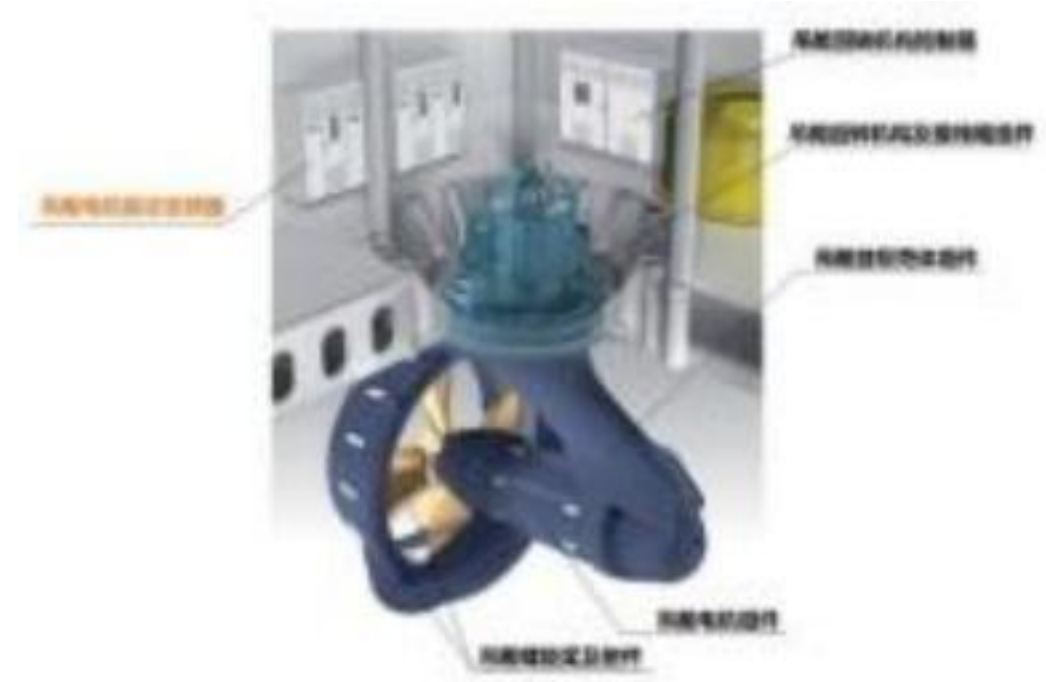

Disclaimer

- The Company offers the details of this vessel in good faith but cannot guarantee or warrant the accuracy of this information nor warrant the condition of the vessel.
 - A buyer should instruct his agents, or his surveyors, to investigate such details as the buyer desires validated.
 - This vessel is offered subject to prior sale, price change, or withdrawal without notice.

 - © Reserved 2023/2024
- 

Environmental Benefits

The pure electric yacht developed in this project can completely realize zero emission during sailing. According to estimates, considering that South-east Asia Region has more than 300 sunny days throughout the year, the daily power consumption is about 1600kWh, and the annual consumption of diesel oil can be reduced by about 70 tons, and the annual carbon dioxide emission can be reduced by more than 200 tons.



Exterior Gallery

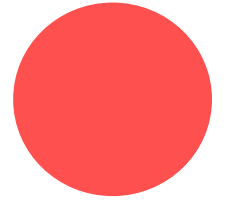
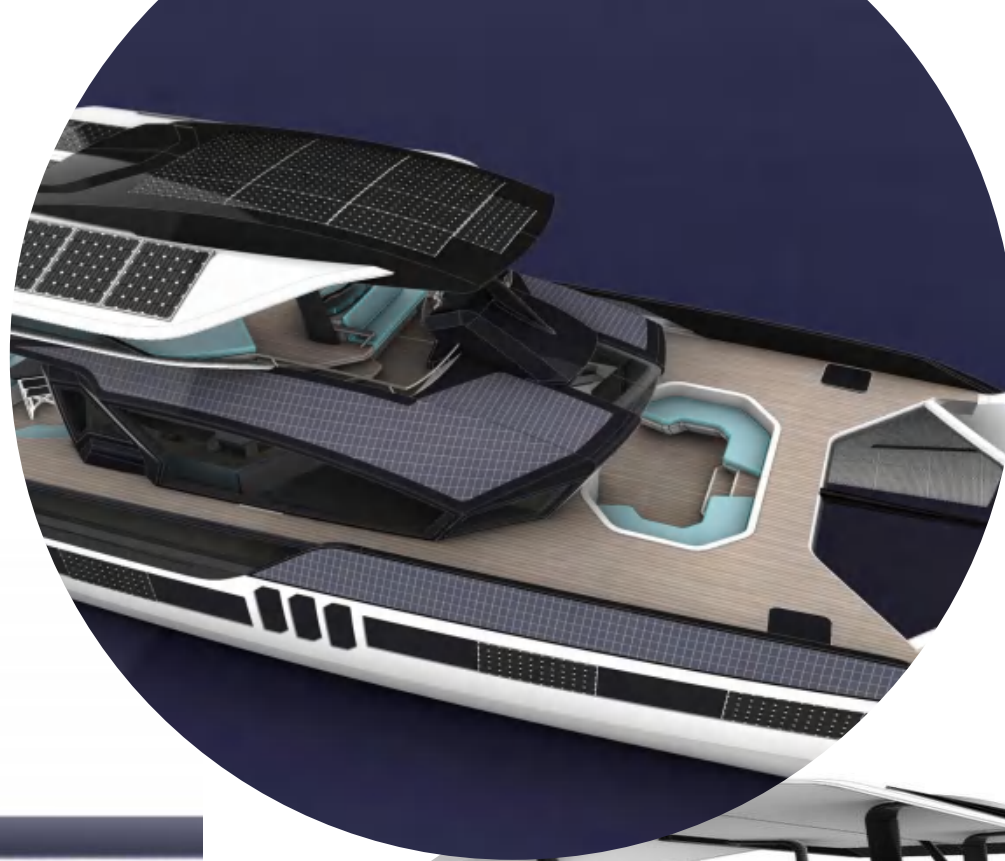

Improved Regulations

- Through this project, we have accumulated experience in the design, construction, configuration of related
- supporting equipment and yacht inspection in the field of pure electric yachts, and through later operations, we
- will lay a solid foundation for the development of pure electric yachts in my country and the formulation of
- technical inspection standards and provide practical reference and suggestions for improving regulations.

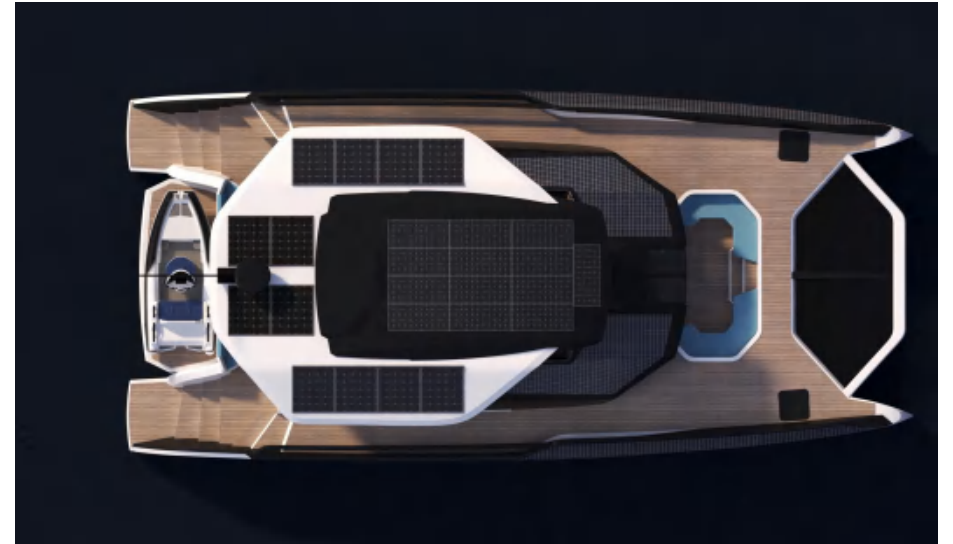

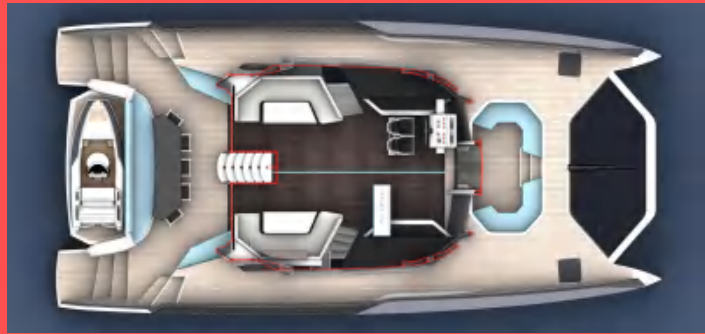



Smart Supervision

With the development of pure electric yachts and the increase in the number of pure electric yachts, a pure-electric yacht operation supervision platform can be built in the future, which can be connected to all pure-electric yachts in South-east Asia Region, and the battery power system and related systems of pure electric yachts operating in South-east Asia Region Realize Safety supervision and ensure the safe and high-quality development of the yacht industry in South-east Asia Region.

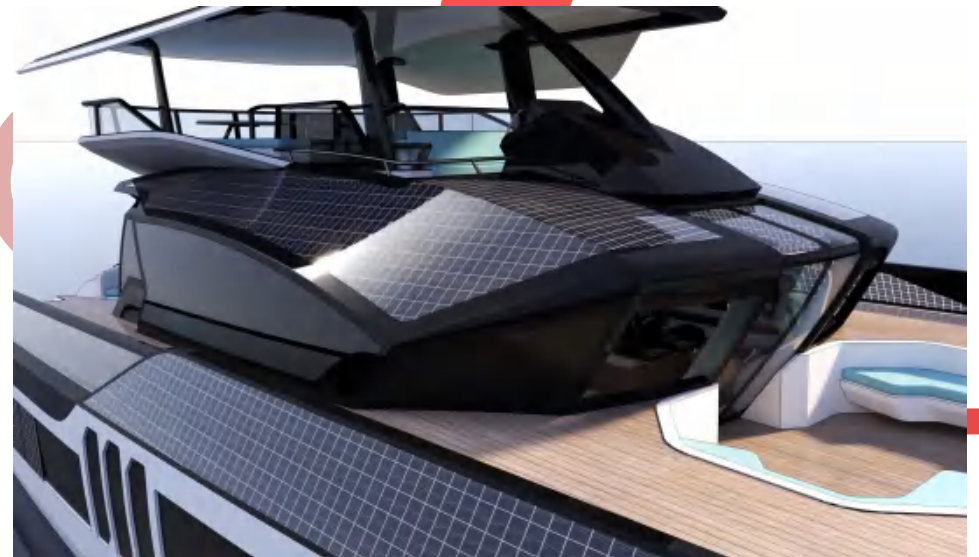





Interior Gallery

- Cockpit and Crew Compartment



Hull Colour Selection

Subject to Customization

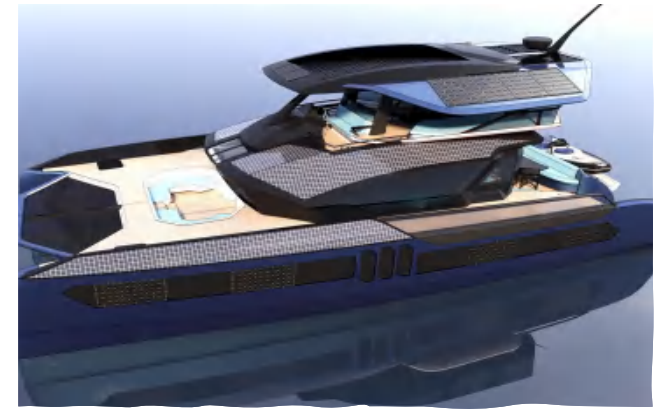
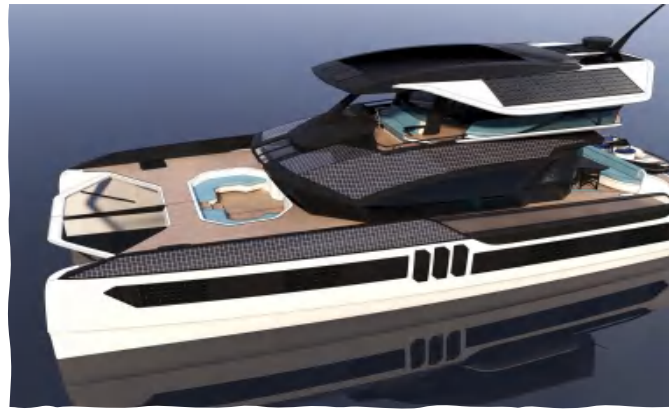
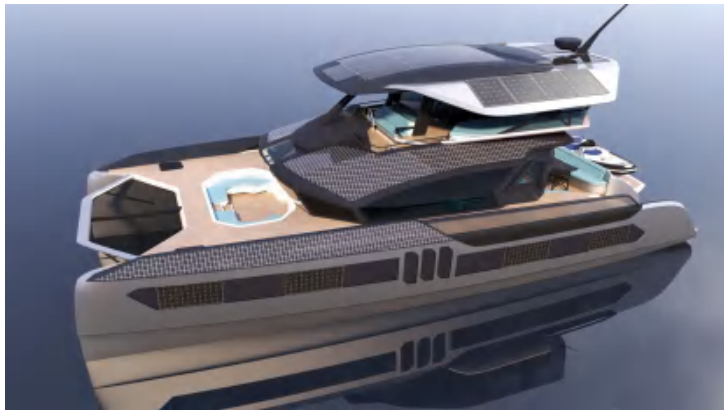
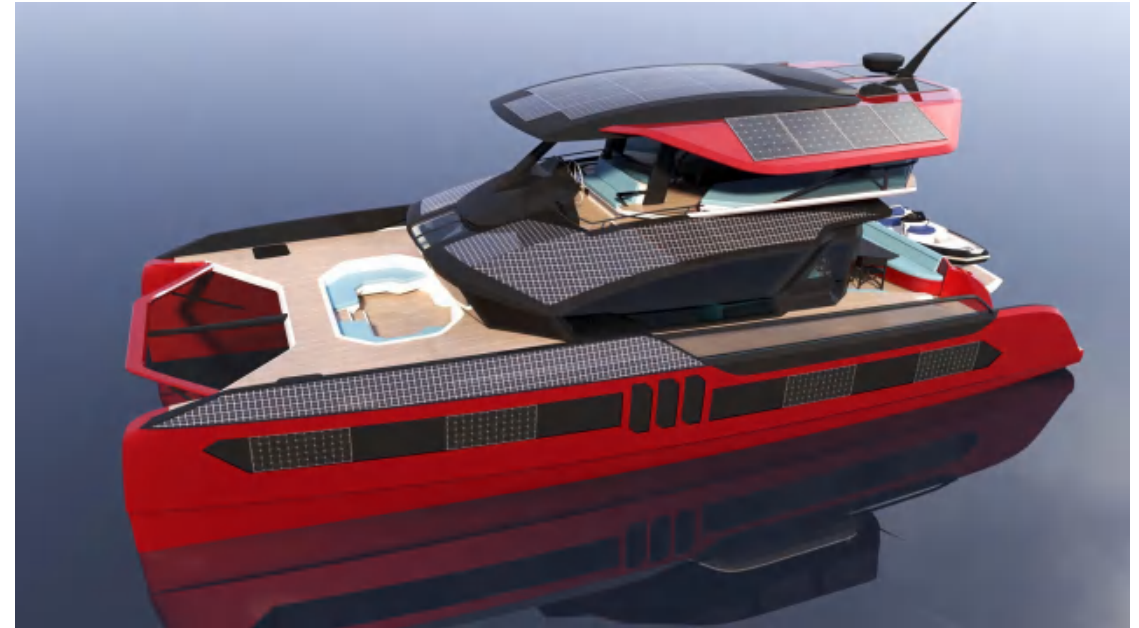



Ship Data Monitoring

Ship Data Monitoring

- This project fully draws on the design experience of the power system of the first large-scale
- all-electric cruise ship “Junlv” in China. On the premise of meeting the specifications, the
- research on the key safety monitoring parameters of pure electric yachts is carried out
- according to the technical characteristics and layout characteristics of the yacht. It also
- provides more data monitoring options and channels for maritime regulatory authorities and
- ship owners.



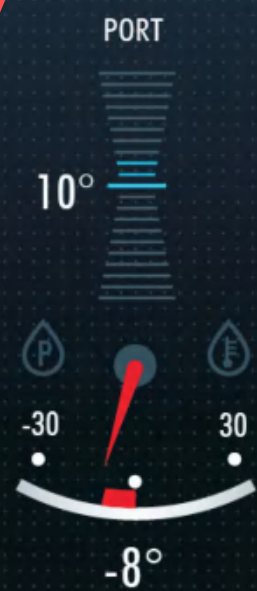
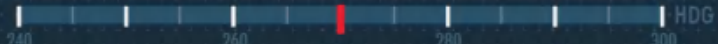

设定锚点

LON

LAT

默认锚点

电子锚距离

- 16 +

电子锚精度

- 5 +



Ship Data Monitoring



Ship Data Monitoring



Ship Data Monitoring





Ship Data Monitoring



12.5



95%

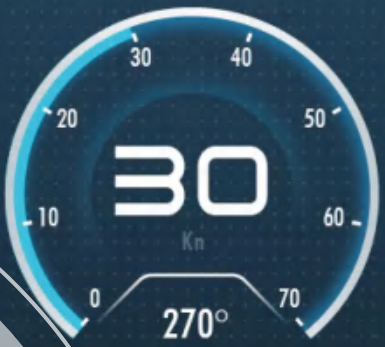

100L/h



12.5

Ship Data Monitoring

Ship Data Monitoring



设定航向

60°

航向精度

5°

°C	10D	120°	3000pa	110mm	35%rh
28°	10m/s	120°	3000pa	110mm	35%rh



120°4'51.12" E 35°44'57.91" N

IN CONTROL

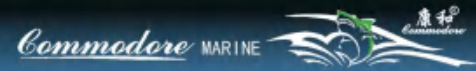

30m

95%

10:58
2022/7/18

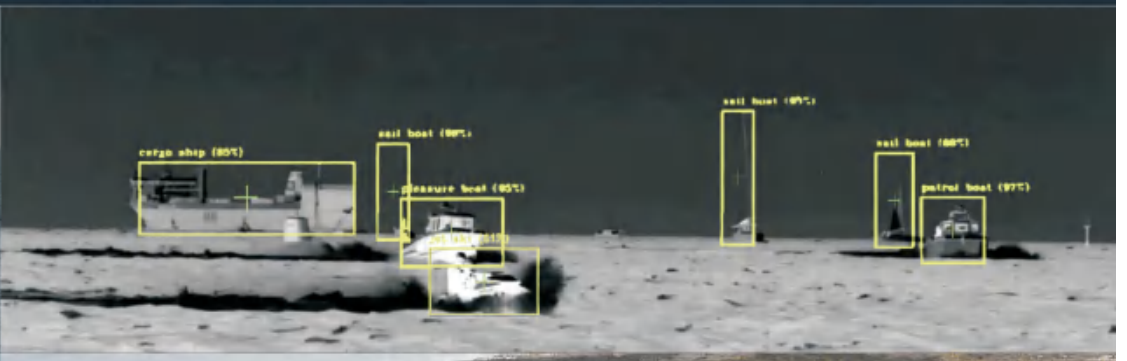
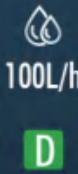
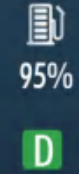

Ship Data Monitoring



The table displays the following data:

编号	时间	SPN	FMI	CM	OC	报警描述
1	2021-04-25 09:02:22	1234567	123	0	123	
2	2021-04-25 09:02:28	1234567	123	0	123	
3	2021-04-25 09:03:32	1234567	123	1	123	
4	2021-04-25 09:05:48	1234567	123	1	123	
5	2021-04-25 09:07:43	1234567	123	1	123	
6	2021-04-25 09:07:55	1234567	123	1	123	
7	2021-04-25 09:08:22	1234567	123	1	123	
8	2021-04-25 09:08:52	1234567	123	1	123	
9	2021-04-25 09:09:28	1234567	123	1	123	
10	2021-04-25 09:10:42	1234567	123	1	123	
11	2021-04-25 09:11:32	1234567	123	1	123	
12	2021-04-25 09:12:58	1234567	123	1	123	

Gottsegen 62 New Energy Catamaran (Limited Edition)

© Reserved 2023/2024